

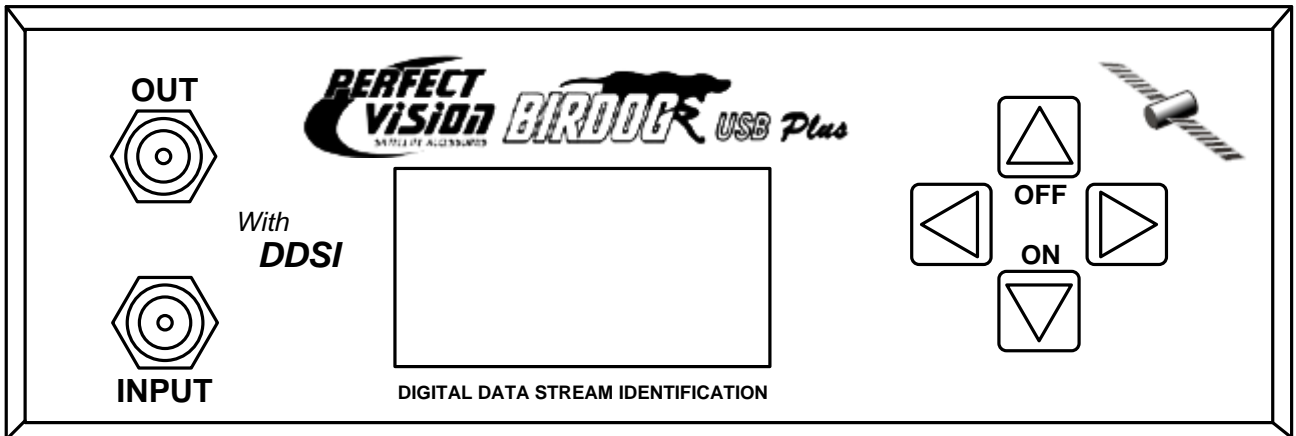

BIRD DOG *USB Plus*
 With **DDSI**
Digital Data Stream Identification



 **Satcom Resources**

Post Office Box 1639
 101 Eagle Road - Building #7
 Avon, Colorado 81620 USA
 970 748-3094 or tollfree 866 SATCOM1
 Fax 970 748-3096
www.satcomresources.com

Publication version 1.8

Contents

Front Cover	
Contents	Page 1
Safety / Satellite Lists	Page 2
Accessories	Page 3
Your Meter	Page 4
Battery Charging	Page 5
Using Your Meter	Page 6
Setup Menu	Page 7
Sub Menu / DiSEqC	Page 8
Spectrum	Page 9
Constellation	Page 10
Custom Carrier	Page 11
Data Logging	Page 13
LNB Cable Test / SWM	Page 14
USB Driver Installation	Page 15
Download	Page 17
Transferring Data	Page 19
FAQ	Page 20
Specifications	Page 21
User Notes	Page 22
Manufacturer's Statements	Back Cover

Thank you for choosing to buy the BirDog USB Plus satellite meter. Please read through the instructions carefully before using your meter to familiarize yourself with all of the new features available.

The BirDog USB Plus is a compact, lightweight and easy to use satellite installation meter featuring an easy to read display that shows signal strength and digital signal quality. Finding your satellite is easy: use the left or right arrow keys to scroll through the selections, and your BirDog USB Plus will lock onto the satellite shown in the display when it is in range. Everything you need is supplied with your meter, which includes a A/C charger cord, in-car charger, USB lead and Port Saver. The rain cover and leather case are already fitted.

The BirDog USB Plus can also be easily re-programmed from the BirDog website www.birdog.tv with your choice of satellites, or with the current default file.

Spare battery packs are available directly from Perfect 10 and can be replaced without voiding your warranty. Replacement leather cases, rain covers, USB leads, A/C charging leads and in-car chargers are also available directly from Perfect-10.

Disclaimer

The satellite operators have complete control of the data stream information. They change the data stream methods and technology at will and for their own purposes. Perfect 10 has no control over the evolution of data streaming. While we will make every effort to provide you with current satellite identification downloads, this device could eventually lose its ability to identify specific satellites by the evolution of technology.

Safety

Safety Instructions



This symbol is intended to alert users of possible hazard or damage in operating this unit.

- Do NOT expose this meter to rain or moisture!
- Clean only with a dry cloth.
- Always use the protective case and cover provided.
- Read the instructions fully before operating your unit for the first time.
- Care should be exercised when using the carry strap as it can present a choking hazard; only use when slipping or falling is not a possibility.
- Do not disassemble your unit or interfere with the internal components; this will void your warranty and there is a possibility of electric shock.

“If the equipment is used in a manner not specified by the manufacturer, the protection provided by the equipment may be impaired”.



- Only use the provided battery, AC charger cord and DC car charger lead provided, as using other types may cause damage to your unit, which will void your warranty and may cause electric shock. Replacement battery packs are available directly from Perfect 10 or an authorized dealer.

Satellite Lists

You can change the pre-loaded satellite list which is currently in the memory of the BirDog USB Plus by going to the www.birdog.tv web site. The instruction set which follows in this manual, “Download”, was current at the time of the manual’s printing but is superceded by any revisions found on the web site.

Note that the BirDog USB Plus may not be able to positively identify the correct locations of satellites other than those in the default menu. Some of the satellites available for download from the BirDog website do cause the BirDog to indicate “Found” in one or more locations. You may download any of these other satellites but they are to be used with the understanding that misidentification may result. A thorough knowledge of the magnetic heading to the satellite you are attempting to positively identify can help you resolve some of the duplicate satellite locations.

The default satellite list which is pre-loaded at the factory will be overwritten by any uploads that you perform. However, the factory default list is also available from the web site and can be re-loaded if desired. Note that the satellites you choose need to be selected in the sequence that you want them to appear in the BirDog USB Plus. If for example, you select a satellite located at 119° and then select one at 101°, the 119° satellite will come up first as you scroll through the list of satellites in the stored memory. This can be handy knowledge as you may prefer to have the satellites you use most, located at the first in the list.

You can load from one to sixty four satellite data lines in memory. The fewer lines you select for your custom list, the quicker you can find the one you want when lining up antennas. Just keep in mind, only one list will be retained in the BirDog Plus memory. The previous list file is overwritten by the next upload you do.

We HIGHLY suggest that if more than one polarity is indicated on the web site for a particular satellite file, that you load both polarities in your BirDog USB Plus. See Page 17 “Download” for an example.

Accessories

Your BirDog USB Plus is supplied with this Instruction Manual and these items below. Please check if you have all the following. If any items are missing please contact your supplier.

 Only manufacturer's replacement parts should be used, otherwise safety of the meter may be impaired

 DC Car Charger Lead
Fitted with 2 Amp Fuse
(BDADAPTOR)



USB Lead (AW998USB)



 AC Charger Lead (BDCORD)



 Battery Pack (BP7233-2)



 Rain Cover
(should be fitted at all times)

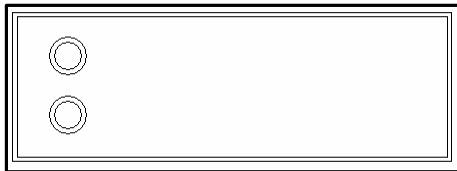

Leather Case (BIRDOGCASE)



Port Saver (PVFIX-2)



Note: The items shown above are subject to change without notice.

Please dispose of the packaging carefully and recycle where possible.

Your Meter

Front View

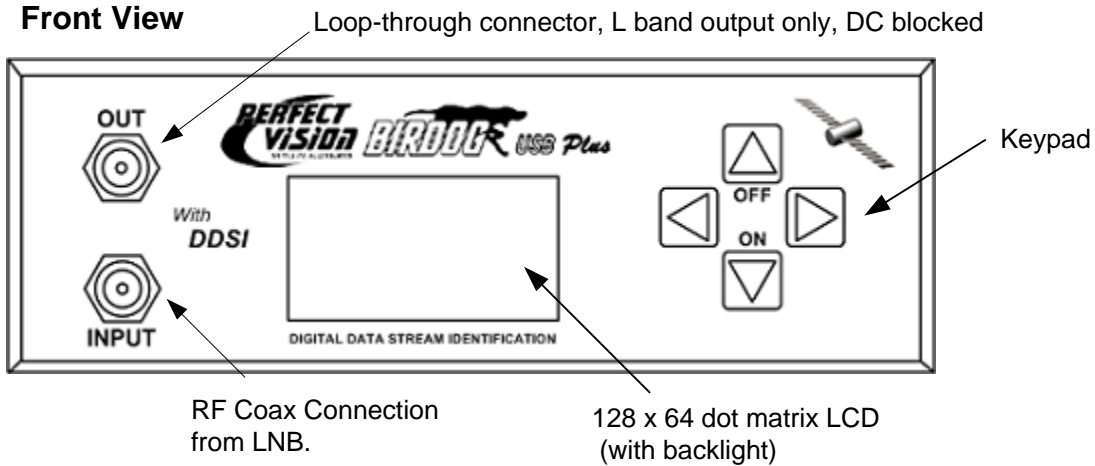

Back View

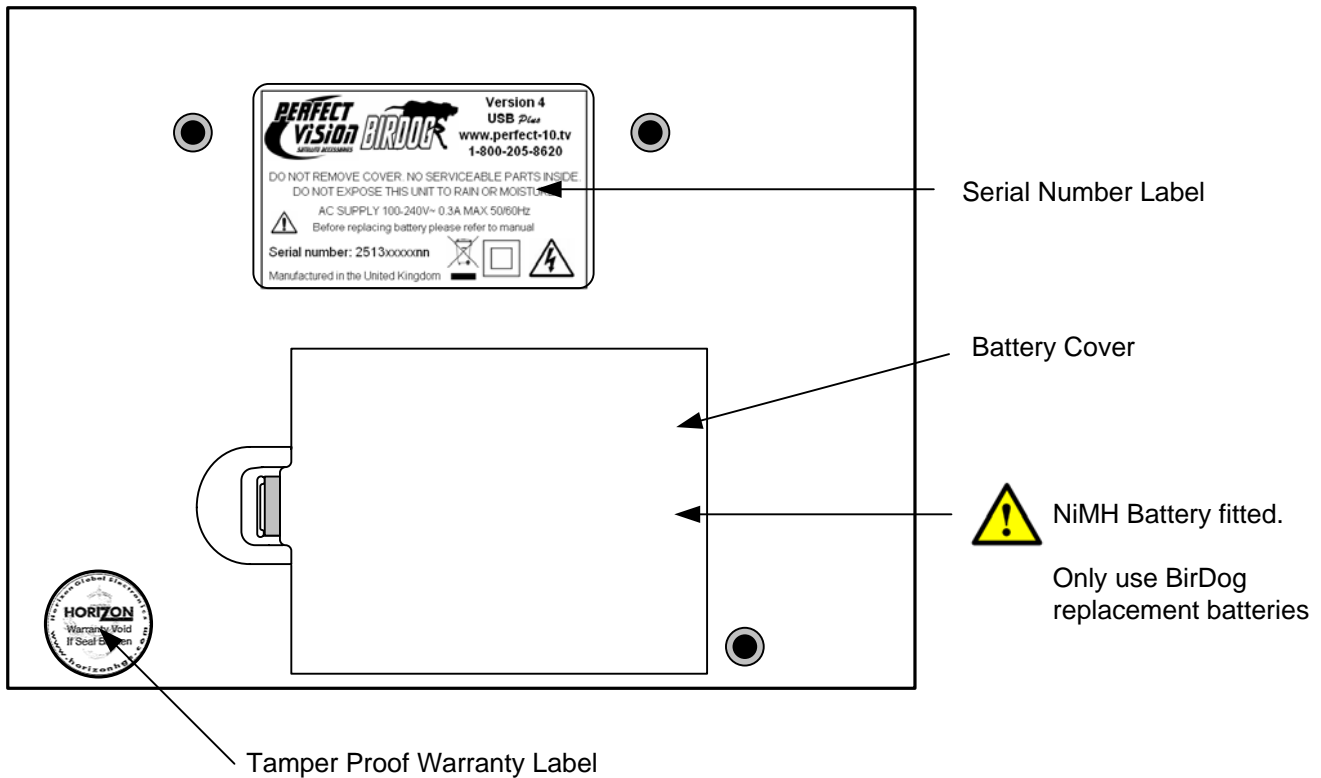

Side View

Rear View

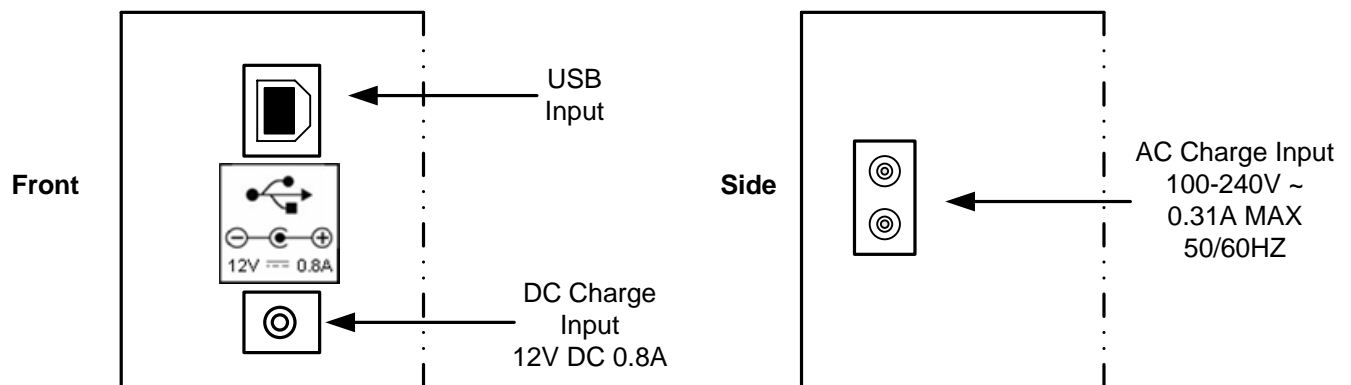

Battery Charging

The meter will NOT be fully charged when you receive it. We recommend you charge it for an initial 24 hours before use. If your meter is not being used for a long period of time, we recommend disconnecting the battery.

The battery pack is replaceable. To replace the batteries: slide the meter out of its protective case, open the cover on the bottom of the unit and disconnect the battery. If the pack has been disconnected, the meter will indicate flat battery (0%). You will still be able to use the meter in this state if the battery pack has been charged. To restore the correct charge reading, charge as shown below until "Trickle" or "Float Charge" is indicated. You can also top up your battery from your vehicle with the in car DC Adapter supplied.



Charging with the mains lead

On the bottom of the case there is a small velcro flap which covers the AC input for charging.



Charging from a vehicle

The vehicle 12V DC charge port is on the right side of the unit. Plug the car charger lead into the bottom socket and the other end to the vehicle's "aux" socket. Please note that on certain vehicles the aux socket is switched off unless the vehicle is running.

For in-vehicle charging only use the lead supplied. The use of another lead may damage the meter and will void the warranty. The BirDog USB Plus can remain connected to either power source in "**Trickle**" charge state for an extended period of time. If the meter is left on charge for over 24 hours the meter will switch to "**Float Charge**" - this is a low cycle charge state and the meter can remain on charge without damaging any internal components or the battery pack.

Note: The meter will not operate while the unit is being charged.

Using Your Meter

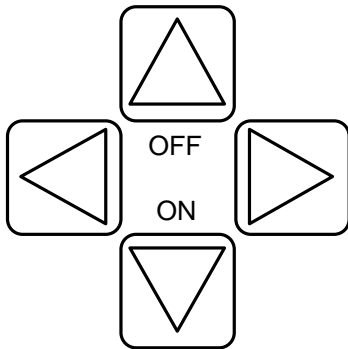

The BirDog USB Plus keypad.
All of the meter functions are accessed from here.

Once your dish mounting has been securely installed in a suitable direction connect the LNB to your BirDog USB Plus meter with a short length of cable (1.5m or 4 feet being ideal): note that this cable is **not** supplied – you should use a high quality satellite cable. **Tip:** Your dish clamp should be just nipping the metal work allowing you to adjust the dish position, and it should hold when you release.

To turn the meter on press the  once and the animated BirDog logo will appear.

The next screen will display the meter information, including model, version, satellite list loaded and battery percentage.



Use the LEFT or RIGHT arrow keys to cycle through the satellites available until the desired one is shown.



Point the dish in the approximate direction of the required satellite, and slowly sweep the dish across the sky, adjusting your elevation at the end of each sweep. While you are sweeping the sky the rate of beeps will change as you pass each satellite; the scale on the meter will also change.

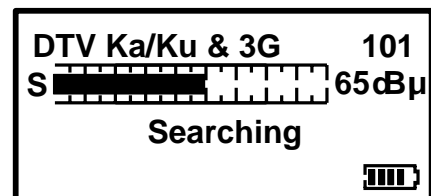

If you would like to look at the signal to noise ratio, the BirDog can provide that information. With the satellite "Found", press the bottom (ON) button once.

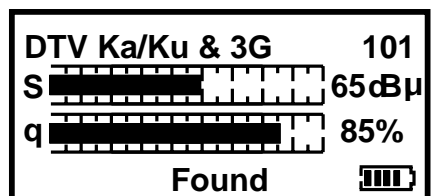

The "S" changes to a "C" and now reflects the C/N or signal to noise ratio in dB. The "v" indicates inverse Bit Error Rate (after error correction).

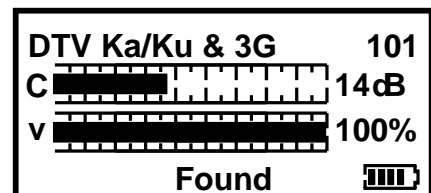

Setup Menu

To access the Setup Menu ensure your BirDog USB Plus is off and press the UP (off) button once. The following options are available from this menu.

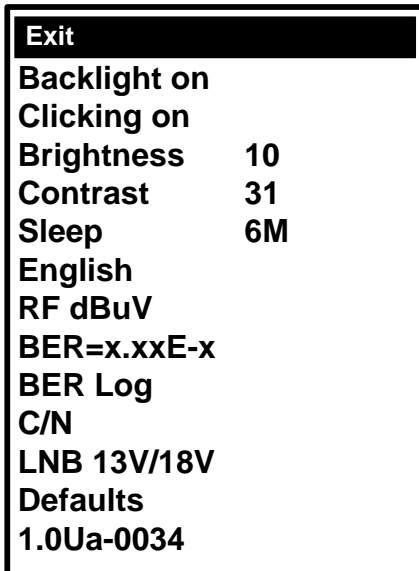

By using the keypad as cursor keys you can navigate through the set up menu using UP and DOWN, and change values by using LEFT and RIGHT keys. Once you have made your selections return to the top of the menu highlighting **Exit** and press the left or right key to apply the changes and switch the meter off.

You can also go back to the default setup by selecting **Defaults**. This operation will not affect any of the satellite settings stored in memory.

Note: The full menu is shown here, whereas only four options are visible at any one time on the LCD display.

The RF can be displayed in either dBuV or Linear modes. The BER numerical display can be changed so that "Found" only is displayed. BER can be measured in Linear mode or for better sensitivity in Logarithmic form (Log). The 1.0Ua-0034 reference may vary; it is for manufacturer use only and does not affect any meter functions.

The BirDog USB Plus supports English and Spanish languages and these are selectable from the setup menu.

Note: MER measurements can also be made by changing **C/N** to **MER** in the setup menu. Results will be logged as C/N (Carrier-to-Noise ratio) or MER (modulation error ratio) according to this setting.

LNB Voltage: This feature enables you to switch the LNB supply voltage off. While the LNB Voltage is set to 0 Volts the Satellite name on the top line of the display will alternate with "**LNB 0V**" to indicate that no LNB voltage is applied. This selection will remain active until it has been changed back to LNB 13V/18V even if the meter is switched off.

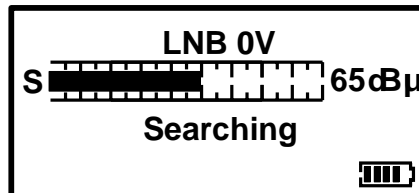
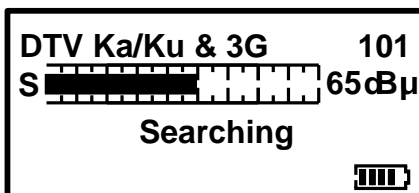

Note: While the LNB Voltage has been selected as 0V then the satellite name on top line of the display will alternate as illustrated above.

BirDog USB Plus Sub Menu

Your BirDog USB Plus has new features available from the **Sub Menu**.

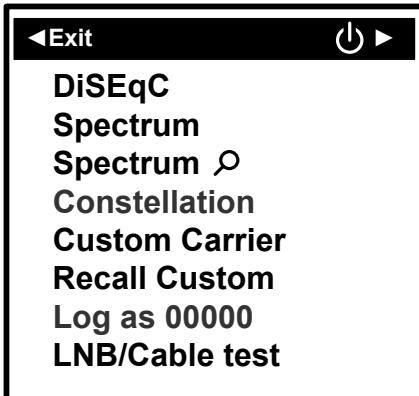

To access the sub menu press the UP (off) button once from the searching screen. Using the keypad as cursor keys you can select the various options. At any time you can press and hold the UP button to switch the meter off. When **Exit** is highlighted, you can also use the RIGHT button to switch the meter off.

The Sub Menu shown here includes all of the new features of the BirDog USB Plus. The Constellation and Log functions are only available once a satellite has been found.

DiSEqC



From the sub menu DiSEqC function shown here you can select a DiSEqC switch command to suit the needs of your installation. Press the right arrow button to access the switch commands available.

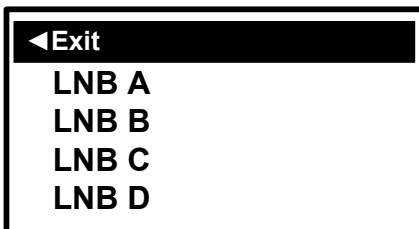

The DiSEqC function gives you the selections of A,B,C and D. Selecting **Exit** here will take you back to the sub menu. Use the Up and Down arrow buttons to highlight the desired DiSEqC command and press the right arrow button to send.

Spectrum Display

Spectrum mode

Spectrum mode is available from the Sub-menu (press the UP arrow while the signal level or carrier/noise display is on screen). Scroll down to highlight "Spectrum", and press the RIGHT arrow. The screen will change to display the spectrum.

The graphic will be centred on the frequency of the selected transponder: in our example of a Low Band setting, the display is centred on 11840MHz. The span (range of frequencies displayed on screen) is set by default to 240MHz; which gives a display of 8 adjacent carriers at 30MHz spacing. By pressing the DOWN button, you can cycle through a range of spans from 60MHz (to zoom in on one carrier in particular) to 1200MHz.

Centre the chosen frequency on the display by pressing the LEFT and RIGHT buttons. Note that you will not be able to go beyond the limits for each band, which are indicated by arrows pointing right (lowest frequency) or left (highest). Note that the Low Band coverage extends from 10700MHz to 11600MHz, and the High Band from 11550MHz to 12750MHz, so there is some overlap between the Low and High Band for Universal LNB's.

RF level is shown by a solid band at each sampled frequency (see image). There will be areas of low-level signal between the carriers, and the bigger the distance between peaks and valleys, the better the carrier-to-noise ratio. Good C/N ratio is important for trouble-free reception!

The top line of the screen alternates between "Center" plus the selected frequency (shown at the dotted vertical line in the centre of the display) and "Span" plus the frequency span in MHz. In "Span" view, the polarization of the carrier (H)orizontal or (V)ertical is shown. If High Band is in use, and 22KHz is enabled, the tone symbol  will appear next to the Polarity.

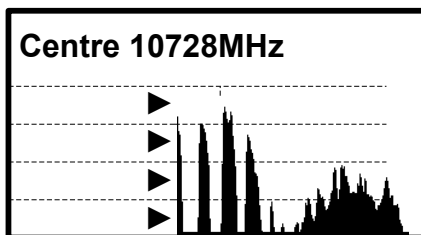

The Spectrum information bar at the top of this screen will alternate between the current frequency and span in use

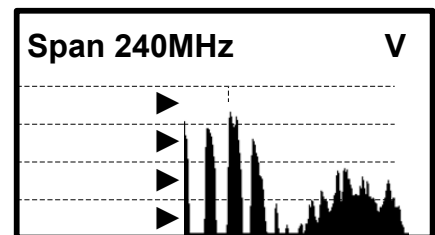

Note: You can exit spectrum mode at any time by pressing the UP button once. This will return you to the searching screen on the selection that you made previously.

In low signal level conditions use the  option to increase the amplitude so that carriers may be seen.

Tip: If you have defined a custom carrier you can view it in spectrum mode too (see Custom Carrier on page 11).

Constellation

Constellation diagram

Provided the meter is locked to a DVB/DSS QPSK modulated carrier, Constellation mode is available from the Sub-menu (press the UP button while the signal level or carrier/noise display is on screen). If there is no lock, the option will be “greyed out”. This type of diagram is almost meaningless when it cannot display formatted QPSK data – dots would appear randomly in each quadrant, and there would be no visible pattern.

In the Sub-menu, scroll down to highlight “Constellation”, and press the RIGHT arrow. The screen will change to the QPSK constellation display and a listing of the current transponder settings.

The graphic displays the 4 quadrants of a QPSK signal. A “good” display will show a cluster of dots towards the outer corner of each quadrant. The more concentrated the cluster, the better the quality of the received signal; dots “straying” from the cluster indicate noise on the signal, phase errors, and other unwanted artifacts.

The aim is to achieve the best result possible, which a thorough alignment of the LNB should achieve. With the constellation diagram, you get reassurance that the adjustments have been done well.

At the right side of the screen is a list of the parameters for the currently chosen transponder:

Frequency in MHz: this is the measured frequency after “pull-in” by the meter’s Automatic Frequency Control (AFC), so the displayed value may differ slightly from the nominated value in the configuration file;

Symbol Rate in kiloBaud (kiloSamples / Second): the data rate is critical in identifying and locking to the selected carrier;

FEC (forward error correction) value: data on the selected carrier will conform to one of a short list of standard FEC values;

IQ Norm indicates that IQ Swap is not present.

At bottom right, there is a display of the charge state of the battery pack.

Tip: The constellation diagram can be used down stream from the LNB to trace problems caused by faulty components that introduce noise and affect the quality of the digital signal.

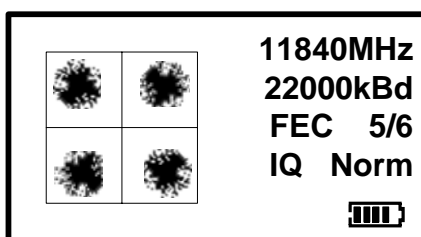

This illustration shows how a typical QPSK constellation diagram would be represented.

Custom Carrier

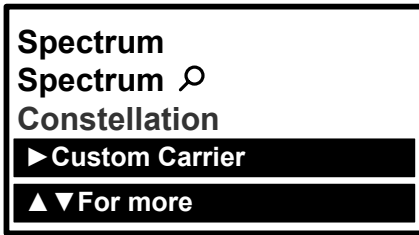

Custom carrier mode is a new feature which enables you to specify your own carrier to lock on to. This can be very useful for optimizing a specific service once the satellite has been located - and this feature can be used for VSAT installation too. You can also store this selection separately from your predefined selections.

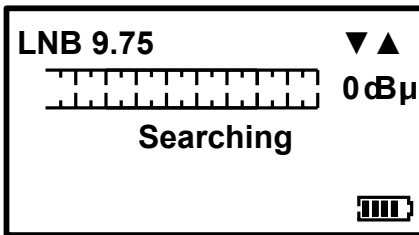

Select your local oscillator first by using the UP and DOWN keys. Various local oscillators are available and some have 22KHz tone available also. The Local Oscillators are shown in the table at the bottom of this page.

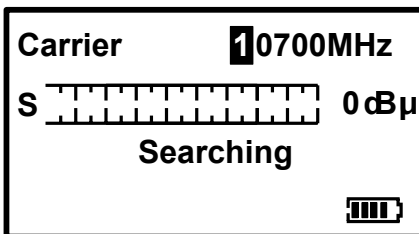

You can set the desired frequency by using the UP and DOWN arrow keys to change the highlighted number and LEFT and RIGHT to step to the next one. Once you have your desired frequency, press the right arrow to step on to the Symbol Rate screen. Note that you will not be able to select out-of-range values (e.g. 20700MHz in Ku band mode).

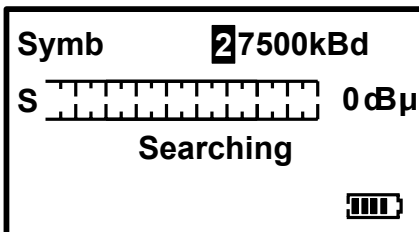

In much the same manner that you defined the frequency, set the Symbol Rate to match the wanted signal: highlight the numbers with the LEFT or RIGHT key and change the value with the UP and DOWN arrow keys. Symbol rates from 01000 to 45000 can be set. Once you have the desired symbol rate press the RIGHT arrow to step on to the FEC screen.

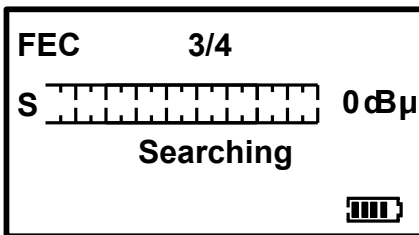

From this screen we can select the desired FEC. If the FEC is unknown then select **Any** and the HDSM USB / USB PLUS will try them all when searching from the Custom Carrier. The FEC's available are show in the table to the right. Press the RIGHT arrow to step on to the LNB voltage screen.

1 / 2
2 / 3
3 / 4
5 / 6
7 / 8
Any

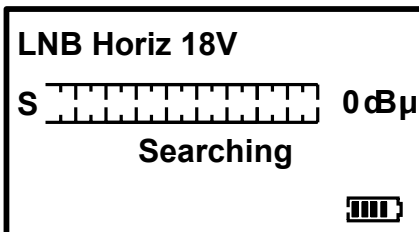

On this screen we can select the LNB voltage: 18 Volts for Horizontal or 13 Volts for Vertical. Press the RIGHT arrow button to step on to the IQ screen.

Note: If you are using a block type LNB for VSAT installation, 18 Volts is typically selected to power this kind of LNB, as the polarization is manually adjusted. Consult your LNB documentation for its operational requirements.

LNB local oscillators supported

Ku-Band	9.75	10.7	11.25 +22KHz Tone	17.25 Ka-Band	5.15 C-Band
	10.6 +22KHz Tone	10.7 +22KHz Tone	11.3	18.25 Ka-Band	5.76 C-Band
	10.0	10.75	11.3 +22KHz Tone	18.75 Ka-Band	5.95 C-Band
	10.25	10.75 +22KHz Tone		19.25 Ka-Band	
	10.5	11.25		19.75 Ka-Band	

Continued...

Custom Carrier

Continued...

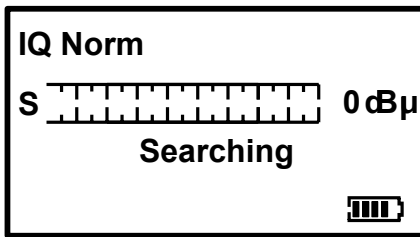

Here you can select IQ un-swapped (Norm) or Swap. Sometimes IQ Swap is required to obtain a lock but for most of the time this is left selected to Norm (Normal). Use the Swap selection if you failed to obtain a lock so far. **Note:** C-Band typically uses IQ Swap.

Press the right arrow key to step onto the Save and Exit screen once you have made your selection.

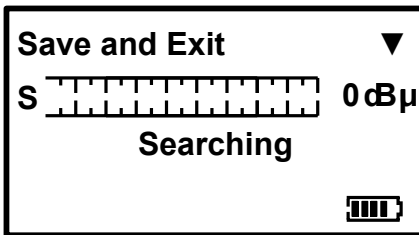

Pressing the DOWN arrow on this screen will save your custom carrier to memory and exit to searching mode, where you can now use your custom carrier settings to find the desired service. If you prefer not to save your settings press the RIGHT arrow to step on to the Discard screen. If you wish to use your custom carrier at a later installation, this can be recalled by using the Recall Custom option from the sub menu.

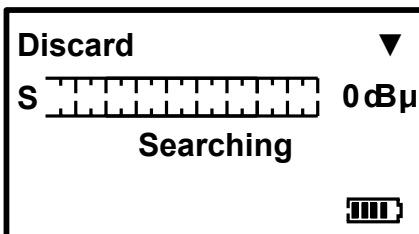

By pressing the DOWN arrow on this screen all of the values you have set will be discarded and the meter will return to searching mode on the last satellite selected before entering Custom Carrier mode. Alternatively, use the RIGHT button to cycle through the custom carrier options to set another carrier of your choice.

Note: The BirDog USB Plus is only compatible with DVB QPSK modulated carriers and will not show a lock on other types of modulation such as DigiCipher, DVB-S2 8PSK or turbo encoded services. When using lower symbol rates (less than 04000) it may take a few seconds to obtain a lock, and it will require much slower motion when pointing your antenna.

Tip: Common carrier configurations can result in a multiple lock situation. For example, carriers that have an FEC of 5/6 and a Symbol Rate of 20000 will probably lock on multiple satellites. Where possible, look for unique Symbol Rates that are unlikely to be duplicated on other satellites at the defined frequency.

Data Logging

Logging

Before using the logging function acquire the satellite that you have chosen, ensuring that the received levels are as good as they can be. Then access the Sub-menu by pressing the UP button once; navigate down and highlight the "Log as 00000" line. By pressing the right arrow at this point the levels from your satellite selection will be stored in to the memory and numbered; this number will increment each time you store your measurements. Note this number down as you will need to refer to it later when downloading the log information from your meter later.

The logging software required to extract the stored values is available from the www.birdog.tv web site.

Note: Before you start to use the logging program please ensure that the USB drivers have already been downloaded as described on pages 15 and 16.

To start the Log Reader program double click the BirDog USB Plus Log Reader program icon (this will look like a target) a small program will appear as illustrated.



Connect your BirDog USB Plus via the USB lead supplied to you PC. Wait for the BirDog Plus to settle in **Program mode** and then click **Read**.

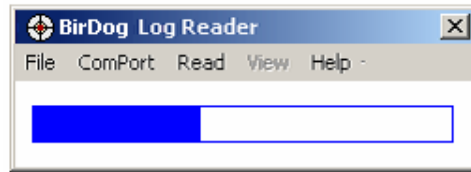

Once the file has been read a pop up will appear "Log download complete"

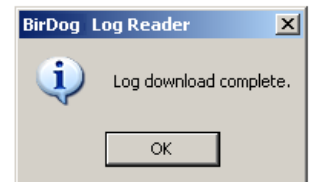

Once you click **OK** you will be presented with a table of your logged measurements. From here you can export this data in CSV (**C**omma **S**eparated **V**alues) format for use with other office programs.

ID	Name	RF Level dBuV	C/N dB	MER dB	Pre Viterbi QBER	Post Viterbi VBER
00025	DTV Ka/Ku&3G 101	65.7	12.3		3.8028e-005	0.0000e+000
00026	DTV Ka/Ku&3G 119	65.7	12.6		1.7881e-006	0.0000e+000
00027	KH SatMex-5 116	65.7	12.3		1.1444e-005	0.0000e+000
00028	KV SatMex-5 116	64.4	12.5		5.7220e-006	0.0000e+000

Buttons: Export (.csv), Close

Remember: When you erase the meter log data the log counter on the meter will not be reset but the stored values will be cleared.

If you wish to erase the current log data within the BirDog USB Plus select the File drop-down menu and click on **Erase Log**.

	A	B	C	D	E	F	G
1	ID	Transponder	RF Level dBuV	C/N dB	MER dB	QBER	VBER
2	25	DTV Ka/Ku&3G 101	65.7	12.3		3.80E-05	0.00E+00
3	26	DTV Ka/Ku&3G 119	65.7	12.6		1.79E-06	0.00E+00
4	27	KH SatMex-5 116	65.7	12.3		1.14E-05	0.00E+00
5	28	KV SatMex-5 116	64.4	12.5		5.72E-06	0.00E+00

LNB/Cable Test

The LNB / Cable test is a quick function to check for possible fault conditions and will indicate if there is a problem.

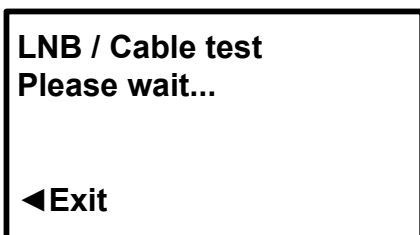

The test results will appear after a few seconds as indicated in the table below.

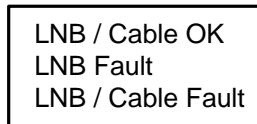

Note: The above function is for indicative purposes only and will not be suitable for DirecTv SWM (Single Cable Router) type systems. This feature tests for an open or short circuit in the cable or LNB and checks RF level with the LNB powered and not powered. It may not indicate 'Fault' if a problem is otherwise related.

DirecTv[®] SWM

The DirecTv SWM (Single Wire Multiswitch) is supported and can be installed using selections downloaded from the www.BirDog.tv Configure web site. This will allow you to perform an installation even if the SWM is part of the LNBF assembly. SWM selections are clearly labeled on the BirDog Configure pick list.

Note: SWM selections are not designed for use with pre SWM assemblies. SWM systems with legacy outputs can use the existing DTV Ka/Ku & 3G selections on the legacy outputs if required.

SWM Output test

The Single Wire Multiswitch output can be quickly checked at the outlet plates of a (typically 8 way) distribution system using a new feature only available on the BirDog USB PLUS. The SWM selection should be used to verify the presence of the required services after the antenna installation has been completed using the 101 and 119 SWM enabled selections.

Histogram function

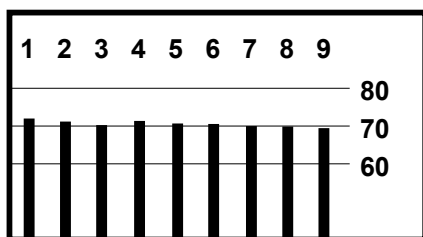

The illustration on the left shows the results found at the distribution points. In this case 9 simultaneous measurements in real time have been made. These 9 measurements reference the SWM translated output frequencies. This quick and easy check tells us that the satellite set top box should function fine as all of the services are available.

The SWM takes the satellite inputs and arranges them into a single continuous extended band. The Histogram displays the presence of these rearranged frequencies.

The 9 frequencies are spaced at regular intervals across L-Band (950 to 2150 MHz)

The Histogram function is available for download as a setting from the www.BirDog.tv Configure web site.

Tip: When downloading from the BirDog Configure web site remember to include all of your other satellite selections (up to a maximum of 64 for the BirDog USB Plus).

USB Driver Installation

Ensure your PC has access to the internet before you proceed.

- 1) Connect the meter for the first time to a PC equipped with USB port(s). If the USB drivers don't automatically load, then the "Found New Hardware Wizard" will appear.

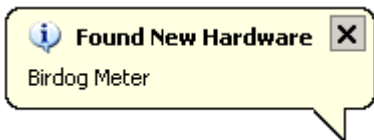

Select "Yes, this time only".
Then click "Next"



Select "Install the software automatically"
Then click "Next"

- 3) While your PC is searching for the drivers a window like this will appear.

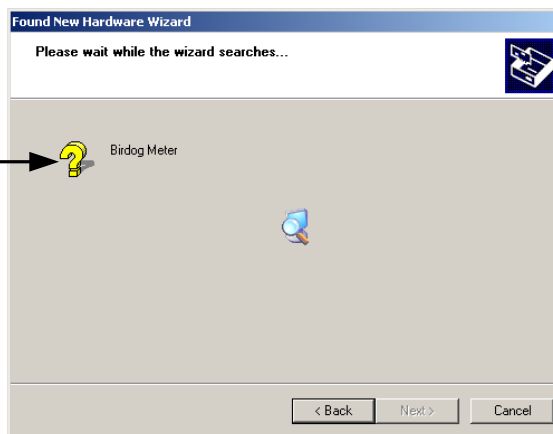

The first stage of the driver installation is now complete; your computer will now proceed to download the additional driver required.

Click the "Finish" Button.

Continued...

USB Driver Installation

Continued...

5)

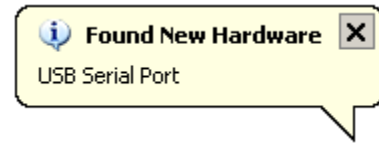

To complete the installation of the new additional driver for the USB Serial Port, click the "Next" Button.

6)

While your PC is searching for the drivers, a window like this will appear.

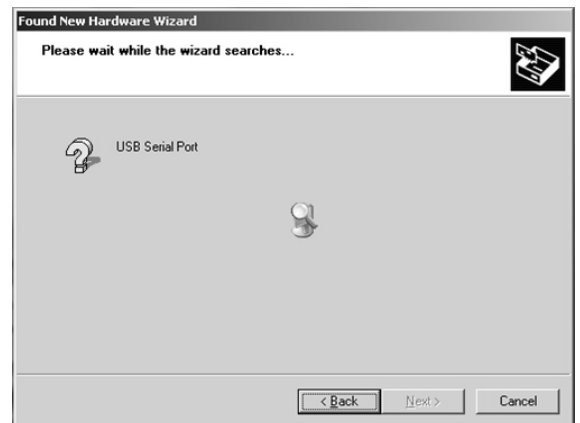

7)



The BirDog USB Plus driver installation is now complete. You can now visit the www.birdog.tv website for downloads.

Click the "Finish" Button.



In the unlikely event of the driver download not automatically taking place the manual driver installation package is available for download from the www.birdog.tv web site.

Download

To change the satellite list in your BirDog USB Plus go to the www.birdog.tv web site and select “**Configure**”. Scroll down to the bottom of the configure page until you see the pick list similar to that shown below.

Note: Satellite names and locations change quite often so don't expect what you see on the web site to be an exact duplicate of the illustration shown.

The screenshot shows a web interface with two main sections: "Available Satellites" and "Selected Satellites".

- Available Satellites:** A list box containing:
 - KV Galaxy-26 93 West
 - KH Galaxy-26 93 West
 - KV Galaxy-3C 95 West
 - KH Galaxy-3C 95 West
 - KV Galaxy-25 97 West
 - KH Galaxy-25 97 West
 - KV Galaxy-16 99 West
 - KH Galaxy-16 99 West
- Selected Satellites:** An empty list box.
- Navigation:** Between the lists are two buttons: ">>" (right arrow) and "<<" (left arrow). To the right of the "Selected Satellites" box are up and down arrow buttons for re-ordering.
- Options:** Below the "Available Satellites" list is a checkbox labeled "Create zipped exe file*". Below it is a note: "*If this boxed is checked you will receive a zip file rather than an exe file. You can use this if you want to download a smaller file, but you will have to unzip it."
- Buttons:** A "Generate" button is located below the "Selected Satellites" list.

First select the required satellite from the “Available Satellites” pick list by clicking on it then click the “>>” button to place it into your selected satellites list.

This screenshot shows the same interface as above, but with different satellite selections.

- Available Satellites:** A list box containing:
 - BR DishNetwork 110 West
 - DishPro 110 West
 - KV HNS SM6 113 west
 - KH HNS SM6 113 west
 - BR Dish500+ 118.7 West (10.75GHz)
 - DTV Ka/Ku 3G 119 West
 - DishPro 119 West
 - BL DishNetwork 119 West
- Selected Satellites:** A list box containing:
 - DTV Ka/Ku 3G 101 West
 - KV HNS SM5 116 west
 - KH HNS SM5 116 west
- Navigation:** ">>" and "<<" buttons between lists; up and down arrow buttons to the right of the "Selected Satellites" box.
- Options:** "Create zipped exe file*" checkbox and explanatory note below it.
- Buttons:** "Generate" button below the "Selected Satellites" list.

In the example shown above only three satellites have been selected.

When you have made your selections (up to a maximum of 64 for the BirDog USB Plus) you can re-arrange the order by using the up and down arrow buttons to the right of the Selected satellites box if you so desire.

Once you are happy with your list click on “**Generate**” to receive your file. A pop-up will appear like the one shown below. Click on “Download your file”.

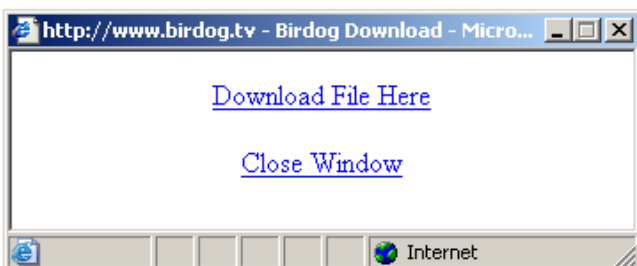

Note: If your web filters prevent the direct download of an .exe file, then check the “**Create zipped.exe file***” option and a zipped .exe file will be sent back to you.

Continued...

Download

Continued...

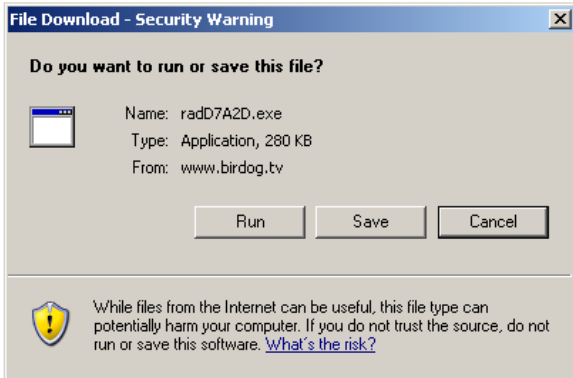

This screen will appear. Click on the **“Save”** button.

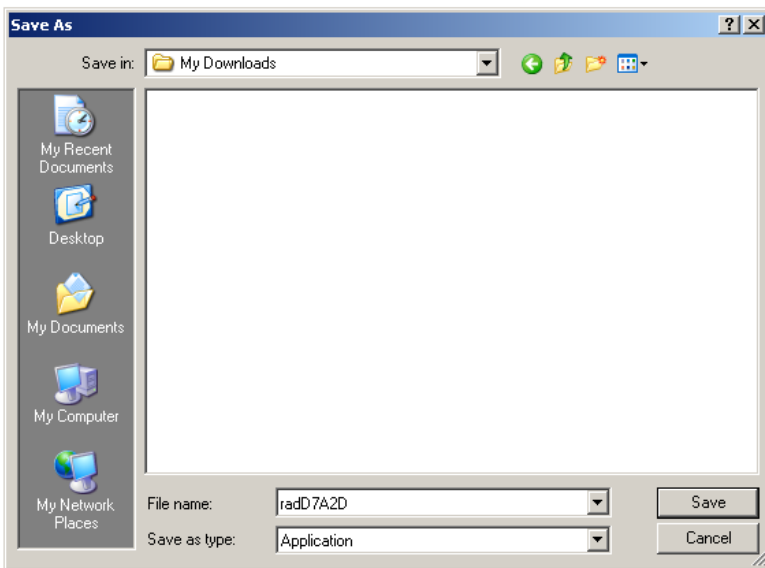

A “Save As” dialog window will appear and you can now choose where you want to store your file on your PC. In this example we have created a folder called “My Downloads”.

Once you have chosen your target folder click on **“Save”**.

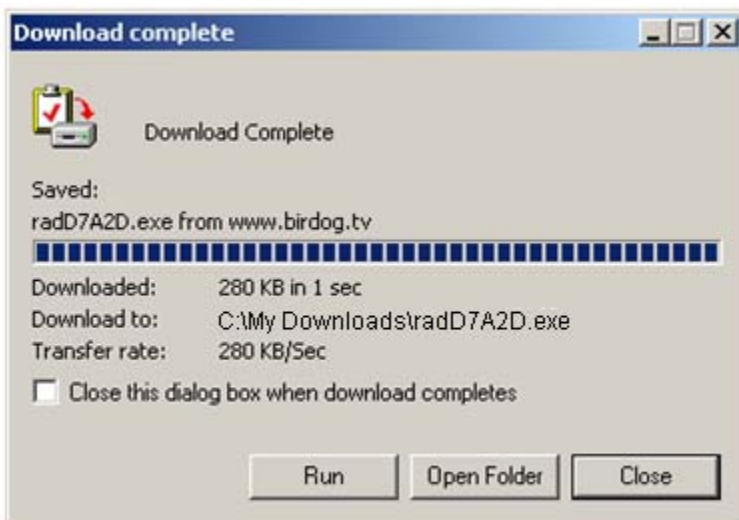

This screen advises you that your file has been downloaded and saved to your chosen folder.

Click the **“Close”** button.

Now that the download has been completed the next step will be to upload your selections to your BirDog USB Plus meter.

You may wish to keep track of the executable file name just in case you want to download a different list of satellite selections from the www.birdog.tv web site at a later date, the file name will be different each time. That way you can pick from previous downloads that you have already stored on your computer.

This example, ‘radD7A2D.exe’ has only DTV 101, 119 and both polarities of SatMex 5 in it you might have more executable files previously downloaded and stored on your computer and each would have a different file name and could contain a completely different list of satellites.

Transferring Data

Now that your USB drivers are installed, you can download selections from the www.birdog.tv website for updates or to create your own preferred list. Please follow the steps illustrated below to upload new selections to your meter.

1)

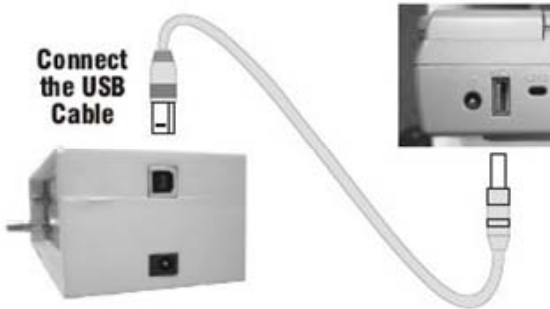

Wait for the BirDog Plus to display "Program Mode"



While establishing communication the display may flash and the sounder may beep. This is normal.

2) Ensure that USB is checked on the ComPort drop-down menu as shown.

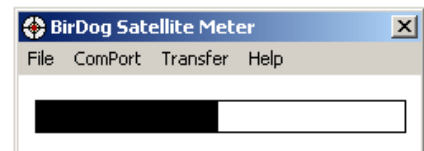
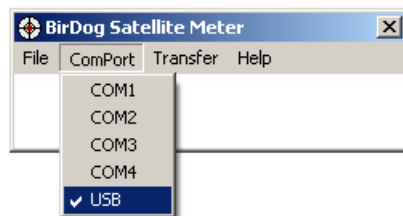

After a few seconds a progress bar will appear

Then click Transfer

3)

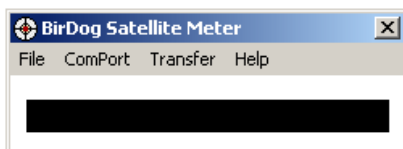

When complete you will see a popup window that says "Transfer Complete!". Click "OK" and close the program.



Disconnect the meter from the computer, power it up and it will be ready for use.

Trouble shooting file transfer problems.

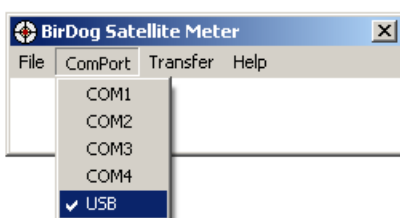

If you receive a Serial Interface error check your COM-port selection, and select the correct COM port. (USB)

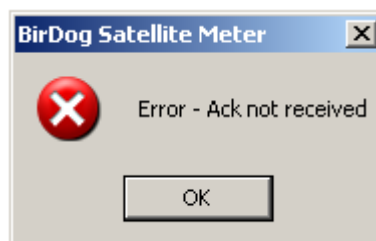

If you get this error message "Error – Ack Not Received". Check that the USB interface connection is correctly made and that the USB cable is undamaged.



FAQ

Ack Not Received Error

- 1) Incorrect Com Port selected. Check to make sure USB Com Port is selected.
- 2) Battery low.

USB Port Error

- 1) Drivers not found (drivers available from website).
- 2) Check that the USB Lead is connected correctly.
- 3) USB Lead may become damaged or a poor connection may cause communication errors.
- 4) USB Port Damaged.

I2C Error Indication

An I2C error indicates that the internal electronics are not receiving correct communication with the internal tuner. Generally caused by:

- 1) Low battery power (if the meter has been left in a cold environment, this will reduce the battery life).
- 2) Connecting the LNB "hot" (i.e. while the meter is switched on) can cause a surge which will result in an I2C error. You should always connect the LNB with the meter switched off.

Meter Shutting Down

- 1) Low Battery Charge.
- 2) Sleep timer – check timer setting in the Setup menu.
- 3) LNB short circuit or drawing excessive current.

Meter does not show a lock.

Make sure you have a current download of files in your meter; if it's been a while since you have downloaded you should do so again.

Also try toggling between BER Linear & BER Log (with meter off, hold UP button down until setup display appears, scroll down to the bottom & you will see BER on left side; press the RIGHT arrow & the right side will change between linear & log. Also confirm in the setup display that you have the meter set to display 'FOUND')

Apple Mac

The software is not MAC compatible.

Storage

If you wish to store your unit for extended periods of time greater than 3 weeks disconnect the battery connectors. When required reconnect and charge overnight prior to use.

Tip: To keep your battery in good working order we recommend a full overnight charge at least once every two weeks for light usage. For every day usage we recommend to put your unit on overnight charge prior to the next working day to ensure maximum battery power is available.

Specifications

Charging

- Universal AC Battery Charger 100V~240V ~ 0.31A MAX 50/60Hz. Intelligent charger (CE approved) with delta V delta T detection, Fast Charge then Trickle.
- DC 12V Charger 0.8 Amps (1.3 Amps peak).
- Figure 8 A/C input connector.
- 2.1mm female plug for external charge via 12 Volt DC 2 Amp fused car charger.
- Run time with full charge, average 5 hours from 3.3Ah NiMH battery

Connections

- LNB input via `F` type female connector. Impedance 75 ohms with short circuit protection - 0.5 Amps automatic limiter
- Computer Interface: USB port for updating satellite settings

Operating Specifications

- RF input range 950-2150MHz - 65dBm to 25 dBm
- LNB Supply Voltage: 13V for V and 18V for H @ 250 mA nominal
- LNB Short circuit protection @ 500mA
- 64 Transponders or 32 Satellites, horizontal & vertical
- DVB, C & KU band, QPSK, VSAT compatible
- Input dynamic range – 65dBm~25dBm
- RF Level can be displayed in dBuV (general accuracy +/-1dB) or linear scale (256 steps). Feature available in setup mode.
- Input impedance 75 Ohms
- Symbol Frequency rate from 1Msps~45Msps
- C/N (carrier to noise) is displayed in dB
- Signal Strength and BER displayed together
- The Quality indicator (pre BER or bit error rate) locks on faster making it easier to identify the satellite initially; typically locks in less than 100mS
- Instead of “Found” to indicate the lock on correct satellites, the actual BER can be displayed. This Feature is available in set up mode.
- Audible and visual tune-in, with selectable and adjustable display backlight and contrast.

User Notes

Manufacturers Notes

The BirDog USB Plus meter has a design temperature range of 32° to 100° F at humidity levels less than 85%. Beyond these limits the meter may not operate properly. At temperatures below 32° the internal battery can lose up to 60% of it's rated capacity; additionally, the LCD (Liquid Crystal Display) can stop displaying information.

It is very important that, in cold weather conditions, the meter is kept in a dry and warm place prior to use.

Satellite selections which utilize left hand circular polarization demand more power from the battery than selections which are right hand polarized. Specifically, LHCP requires 18vDC and RHCP 13vDC.

The Manufacturer suggests that, in cold weather conditions, the meter be kept warm, fully charged and connected solidly to the LNBF before attempting to turn the meter "ON".

Two error codes you might encounter with the BirDog meter are "Empty Table" and "I2C Error".

The "Empty table" text display indicates that the download from the www.birdog.tv web site did not complete correctly. Re-select desired satellites from the BirDog web site and download the file again.

The "I2C" Error indicates that the internal electronics are not receiving correct communication with the internal tuner. This can be caused by low batteries (typically in cold weather), a high amp demand form the LNBF/Switch set, loose connections between the meter and the LNBF or switching to LHCP with a weak battery.

Replacement Part Numbers

A/C Charger Cord	BDCORD	Protective Case	BIRDOGCASE
D/C Auto Charger Cord	BDADAPTOR	Port Saver	PVFIX-2
USB Interface Cord	AW998USB	Rechargeable Battery Pack	BP7233-2

Utility of this device

The satellite operators have complete control of the data stream information. They change the data stream methods and technology at will and for their own purposes. Perfect 10 has no control over the evolution of data streaming. While we will make every effort to provide you with current satellite identification downloads, this device could eventually lose its ability to identify specific satellites by the evolution of technology.

Warranty

Perfect 10 Satellite Distributing will, at our option, repair or replace any BirDog meter found defective in manufacture within a warranty period of one year. This warranty period is determined from the date of purchase. Keep your receipt as proof of purchase date. Otherwise, the warranty is determined by the date of manufacture. This warranty does not apply to damage caused by accident, misuse or tampering with the unit. Removal of tamper seals attached to the meter or installation of replaceable battery packs not provided by or approved by either Perfect 10 or Horizon Global Electronics Ltd. (the manufacturer) will void this warranty. Connection cords and cables provided with the meter are warranted for ninety (90) days.

Perfect 10 Satellite Distributing
3901 Progress Street
North Little Rock, Arkansas 72114

1-800-205-8620